

MASS AND HEAT-INSULATION PROPERTIES OF THE BODIES OF PASSENGER AND INSULATED RAILWAY CARS MADE OF VACUUM HONEYCOMB PANELS

Anatoly Balalaev*¹ Maria Parenjuk¹ Ismagil Arslanov² Artur Ziyatdinov²

¹Samara State Transport University, Faculty of Rolling stock and railway machines, Department of Wagons, Samara, Russia

²Ufa State Petroleum Technical University, Department of Mechanics and mechanical engineering, Ufa, Republic of Bashkortostan, Russia

The goal of the study is to suggest an algorithm for optimizing honeycomb vacuum panels geometry to be used for the bodies of railroad passenger cars and insulated railroad cars, which would ensure the desired car strength, its minimum mass and improved heat-insulation properties. For the calculation of panel strength and heat transfer characteristics, the method of finite elements in the SolidWorks Simulation environment was used. An optimization criterion was suggested for the honeycomb structure of panels, which made it possible to select the panel geometry ensuring a minimal body mass for a passenger or refrigerated railroad car and the best thermal resistance for its enclosure. Static load strength tests of the models of passenger/insulated railroad car bodies made of solid plates identified the minimum permissible panel plate thickness for different parts of the car body. Comparative trials and examinations of solid plates and honeycomb panels revealed the optimum honeycomb panel structure variants for different parts of the car body based on the optimization criterion minimum. Having replaced solid plates in car body models with profile-optimized honeycomb panels, we defined the mass and thermal resistance of the cars. For a passenger car, the mass of the body amounted to 11.14 t, the average thermal resistance was 3.187 m²K/W; for an insulated car, the mass of the body was 20.42 t and the average thermal resistance 6.211 m²K/W.

Key words: Passenger car, Insulated car, Car body, Thermal resistance factor, Factor of safety, Insulating properties, Vacuum panel

INTRODUCTION

Background

Nowadays, for bodies of passenger and insulated railroad cars, in order to ensure thermal resistance, thermal insulation materials, such as polyurethane, are used [16] (p.538). The car bodies are made either with a frame, transverse ribs and plating of sheet metal [16] (p.527), or using long moulded honeycomb aluminium panels [15] (p.192). Honeycomb panels have found use not only in railroad passenger car structures but also in freight wagons, for instance in gondola cars [11] (p.36). Besides aluminium alloys [06] (p.137), there have been attempts to use composite materials, e.g. fibre-glass [17], for freight wagons structure. [19] (p.15) and [01] (p.107) proposed to use for thermal insulation, instead of urethane foam, cavity panels with ribbing made of polyamide that are hermetically welded at ends and pumped out to the remaining vacuum value of less than 1 kPa. Such panels are characterized by the property of vacuum thermal insulation [07] (pp.2–4) that is being used today chiefly in space engineering [08] (pp.1–3) due to its high cost.

At the same time, the low cost of polyamide makes it possible to use this material in vacuum panels for passenger and thermally insulated railroad cars.

Topicality of the issue

As was already suggested by [12] (p.79) and [20] (p.23), the reduction of energy cost of passenger and insulated railroad car operation can be achieved by lowering the heat transfer factor of the walls and bodies of the cars, which is an urgent issue of the day. [19] (p.20) analyse mechanical and heat insulation properties of the body of an insulated car made of long vacuum panels of honeycomb polyamide; the honeycomb structure is comprised of regular hexagons. In [01] (p.113) similar calculations are proposed for the body of a freight wagon made of long vacuum honeycomb panels comprised of regular triangles. What is necessary for generalisation and summarising of the findings, however, is an algorithm for optimization of the geometry of random structure panels capable of ensuring — with the desired mechanical properties — the minimum mass of the car body (for passenger or insulated cars) and better thermal insulation characteristics.

Goals and objectives of the study

The goal of the study is to suggest an algorithm for optimizing honeycomb vacuum panels geometry to be used in the bodies of passenger cars and insulated railroad cars, which would ensure the desired car strength, its minimum mass and improved heat-insulation properties.

METHOD

Description of the study method

To achieve the goal, we applied the method of CAD-engineering of 3D models of passenger/insulated railroad cars made of uniform thickness plates, using the SolidWorks environment. After that, the models were analysed for static strength in the SolidWorks Simulation software package, by the finite element method [04] (p.13) with loads applied in compliance with Russian national standards [13] (p.11–26), in order to define the minimum allowable thickness of the plates. In the following step, comparative analyses of standard plate sample models having minimum permissible thickness and of honeycomb panels having different geometry were carried out in the SolidWorks Simulation environment [01] (p.113). Having ensured equal mechanical strength, by a sequential search of variants [02] (p.113) and [10] (p.84), the optimum geometry of the honeycomb structure with the minimum mass was defined. In the SolidWorks Simulation software package, a thermal analysis of the standard sample model with the optimum geometry honeycomb structure was carried out in order to define the net heat flux [19] (22). What these methods lack is generalization to optimize the honeycomb random geometry structure by two parameters: the mass and the average thermal resistance.

Generalized method’s algorithm

The proposed algorithm is based on that of optimizing the structure of railroad car bodies made from honeycomb vacuum panels, by the criterion of mass with a given mechanical strength [01] (p.114); the algorithm can be summarized as follows:

1. Development (in SolidWorks) and subsequent examination (in SolidWorks Simulation) of 3D models of car bodies made from solid plates of a given material, with the same thickness for each part of the body (floor, sidewalls, end walls, roof), of three types (flat plate, bent plate, hollow ball segment), mechanical strength testing and choosing the minimum permissible thickness for each part of the body;
2. Optimization, by a sequential selection of all vacuum panel structure parameters (the number of comb rows, outer walls thickness, inner ribs thickness), using the minimum value of a generalized criterion, provided that the mechanical strength was equal to that of a standard solid plate sample of the minimum permissible thickness that was defined at the first step of the algorithm for each car body part;
3. Calculation of the mass and thermal resistance of each body part (floor, sidewalls, end walls, roof) made of honeycomb panels of the optimal structure that was defined at the second step of the algorithm for each body part.

Generalized optimization criterion

For a generalized optimization criterion, the following expression was suggested:

$$K_{opt} = \left(\frac{M_{cp}}{M_{sp}} \right)^a \cdot \left(\frac{R_{tsp}}{R_{tcp}} \right)^{\frac{1}{a}} \tag{1}$$

where M_{cp} is the mass of a standard honeycomb panel with preset structure parameters and strength equal to that of a standard solid plate, kg; M_{sp} — mass of a standard solid plate of the minimum permissible thickness defined by static strength analysis of a car body 3D model, kg; R_{tsp} — thermal resistance of a standard solid plate of a thickness equal to that of a standard honeycomb panel, m²K/W; R_{tcp} — average thermal resistance of a standard honeycomb panel with preset structure parameters, m²K/W; a — weighting factor with the values chosen from the range of 0.1 to 10.

Thermal resistance of a standard solid plate depends solely on its thickness and heat conductivity of the material of which the plate is made. The value of heat resistance R_{tsp} is defined by the Equation (2) [09] (p.132):

$$R_{tsp} = \frac{\delta_{sp}}{\lambda_{sp}} \tag{2}$$

where δ_{sp} is thickness of the plate, m; λ_{sp} - thermal conductivity of the plate’s material, W/(m K).

For each car/wagon type, it is recommended to define an optimal honeycomb panel structure by the minimum value of the generalized criterion (1) with several different values of the weighting factor. Thus, for a passenger railroad car, the crucial optimization factor is minimal mass, hence it is recommended to set the values of the mass factor as $a = 1.5$; 2. For an insulated car, the most important factor is the maximum of thermal resistance, therefore it is recommended to set the weighting factor values as $a = 0.5$; 0.75.

Working out the study algorithm in detail

At the first stage of the study, 3D models of passenger and insulated railroad car bodies made of equal thickness solid plates of three types (flat plate, bent plant, hollow ball segment) were built in the SolidWorks. An explosive view of a passenger car body model is shown on Figure 1.

An explosive view of a model of an insulated car body is shown on Fig. 2.

Figure 3 illustrates solid plate types: a flat plate, a bent plate, a hollow ball segment.

When studying a passenger car model for static strength in the SolidWorks Simulation, the loads recommended by the “Russian national standards for calculation mechanical strength of railroad cars” were applied to it [13] (pp.11–26).

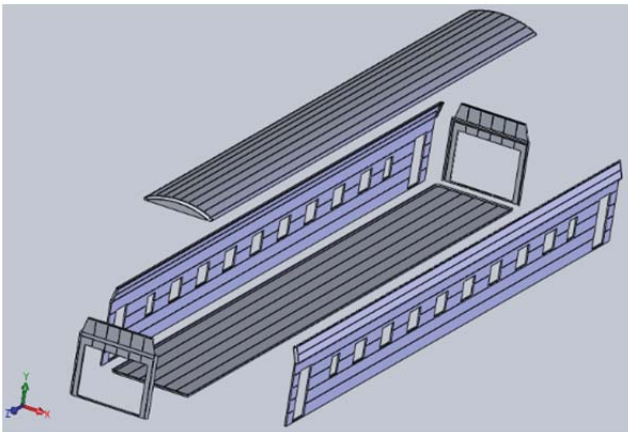

Figure 1: Explosive view of a model of passenger car body

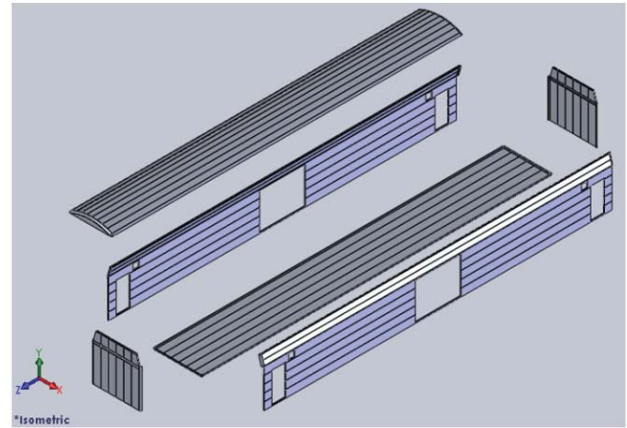

Figure 2: Explosive view of a model of an insulated car body

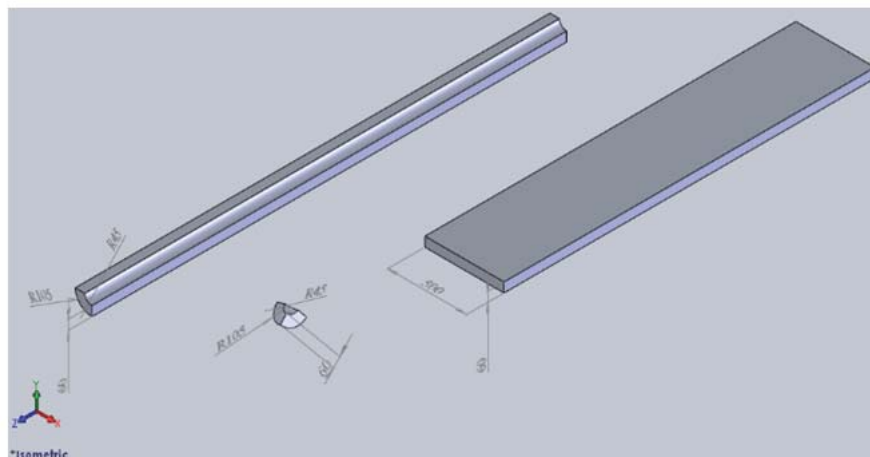

Figure 3: Solid plate types

The body of a passenger car, in compliance with [13] (p.11), is to be calculated for static strength in the following modes: I (emergency collision when manoeuvring) and III (motion at a design speed of $V = 160$ m/s).

The mode I, the most dangerous one, was chosen as the design conditions.

For a passenger car, load calculation in mode I as per [13] (pp.11–26) has shown the following values of co-acting forces:

- total vertical load $P_{VDL} + P_z = 1.319$ MN;
- axial inertia of the car body $P_{LFI} = 1.577$ MN;
- projections of the load of a water tank, 1 000 kg:
 $P_{mx} = 0.049$ MN, $P_{mz} = 0.0049$ MN,
- projections of the load of a water tank, 800 kg:
 $P_{mx} = 0.0392$ MN, $P_{mz} = 0.0039$ MN,

where the following subscript indices are used: P_{VDL} is projection of the vertical dynamic load, P_z - projection of a load due to the mass of interior equipment, cargo and passengers onto the axis Z, P_{LFI} - projection of the longitudinal force inertia, P_{mx} - projection of the load onto the axis X, P_{mz} - projection of the load onto the axis Z.

The described loads were applied to a 3D model of a passenger car body made of solid plates as remote force loads.

The body of an insulated car, as per [13] (p.11), is to be calculated for static strength in mode I (a relatively rare co-action of extreme loads) and for endurance in mode III (a relatively frequent co-action of moderate loads that are characteristic of a normal car operation within a train moving with the design speed of $V=140$ m/s).

As design conditions, mode I (static strength) was chosen, in which, as per [13] (p.11), co-acting inertia forces of axial and vertical acceleration of the masses of different parts of the car body, cargo and equipment are to be considered [13] (clause 2.4.2 (p.17)). Projections of the inertia forces are found by the formulas:

$$P_{MiX} = m_i \cdot a_x, P_{MiY} = m_i \cdot a_y, P_{MiZ} = m_i \cdot a_z \quad 2)$$

where P_{MiX} is projection of inertial force due to the mass of the i -th object onto the axis X running along the movement, P_{MiY} — projection of inertial force due to the mass of the i -th object onto the axis Y running across the movement,

P_{MiZ} - projection of inertial force due to the mass of the i -th object onto the vertical axis Z , i - current order of the object, and $a_x = 6.5 \text{ g}$ (g is downward acceleration); $a_y = 0$; $a_z = 0.8 \text{ g}$ [13] (Table. 2.6 (p.26)).

In an insulated car, for calculation of loads in mode I, the following values of co-acting forces were defined:

- projections of the load of electrical equipment, 800 kg, on the roof: $P_{MaX} = 51\,000 \text{ N}$, $P_{MaZ} = 14\,112 \text{ N}$;
- projections of the load of the roof and electrical equipment with a total mass of 12 317 kg on the body walls: $P_{MbX} = 784\,593 \text{ N}$, $P_{MbZ} = 217\,272 \text{ N}$;
- projections of the load of the walls, roof and electrical equipment with a total mass of 36 175 kg upon the bearing surface of the car body floor under the walls: $P_{McX} = 2\,304\,348 \text{ N}$, $P_{McZ} = 638\,127 \text{ N}$;
- projections of the load of cargo and two refrigerators with a total mass of 43 187 kg on the bottom of the car body: $P_{MdX} = 2\,751\,000 \text{ N}$, $P_{MdZ} = 761\,815 \text{ N}$,

where the following subscript indices are used: MaX , MaZ - values of MiX , MiZ when $i = a$; MbX , MbZ - values of MiX , MiZ when $i = b$; McX , McZ — values of MiX , MiZ when $i = c$; MdX , MdZ - values of MiX , MiZ when $i = d$.

When analysing railroad car models for static strength in the SolidWorks Simulation, the thickness of solid plates was initially taken as the same for all parts of the body and, alternatively, as a priori large, for instance, 100 mm. The plates' material was chosen arbitrarily, for instance, aluminium alloy 6063-T83. Later, the thickness of the plates was reduced to a lowest permissible value with which the pre-given value 2 of the minimal factor of safety was assured (i.e. the ratio of material yield strength to the maximum stress). The part of the car was identified where the maximal stress occurred. Normally, it is the bottom of the railroad car. The plate thickness for it was fixed, while for other parts it was reduced with the increment of 5 mm to minimal values with which the minimum factor of safety remained unchanged. As a result of the analysis, the plate thickness for different parts of the car body was found out, for which the value of the minimum factor of safety was 2, i.e. the one that was permissible for the car body.

In car model calculation for static strength in the SolidWorks Simulation, the spacing of the finite element method's mesh in all studies was taken as equal (a curvature-based mesh with 6.3 mm spacing).

At the second stage of the study, mechanical strength properties of flat solid plate models and flat honeycomb panel models were compared. For this, a standard geometry similar for all studied models was chosen: width 500 mm, length 100 mm. Figure 4 shows the load configuration of a solid plate, thickness 40 mm, of aluminium alloy 6063-T83. The upper face of the plate, secured at its sides, was loaded by force F whose value was chosen under the condition that the minimal factor of safety permissible for car body was equal to 2. As a result of the calculations, the force intensity was found out.

Figure 4 shows similar loading schematics of a honeycomb panel made of polyamide PA-6 with cells of regular triangles arranged in one row, with the thickness of 126 mm.

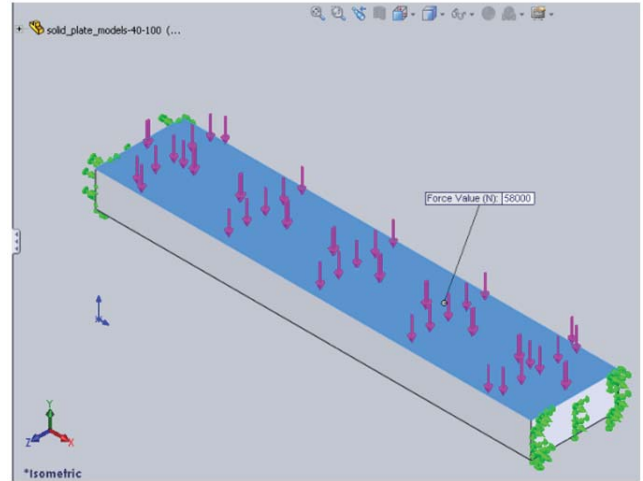

Figure 4: The diagram of solid plate mounting and loading

The panel was also secured at its sides and loaded along its upper face with a force whose intensity was determined in the studies of a solid plate. Besides, the outer surface of the honeycomb panel was loaded by 100 000 Pa pressure, imitating the ambient air pressure affecting a vacuum-sealed hollow body.

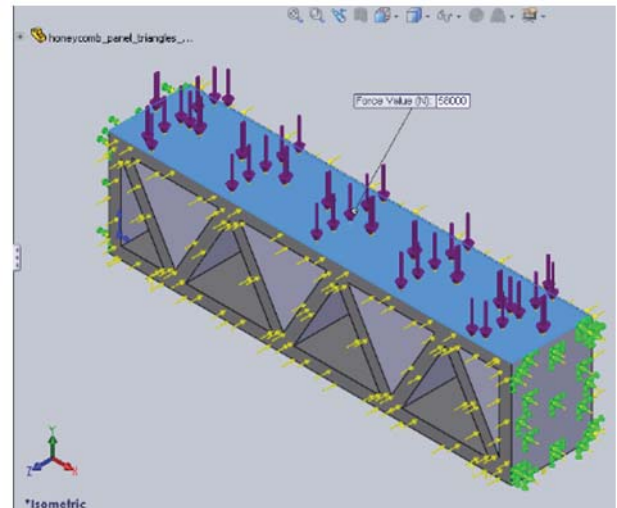

Figure 5: The diagram of honeycomb panel mounting and loading

In solid plate/honeycomb panel model calculations for static strength in the SolidWorks Simulation, the spacing of the finite element method's mesh in all studies was taken the same (a curvature-based mesh with a 6.3 mm spacing). Mesh parameters for the honeycomb panel model with a regular triangle structure is shown on Figure 6.

In addition to studying standard honeycomb panels for strength, they were also analysed for thermal properties in the SolidWorks Simulation by the finite elements method. In accordance with [21] (p.7), boundary conditions of type I were the following: for the upper face of the panel, a maximum temperature was set as $T_{max} = 293$ K, whereas for the bottom face, a minimum temperature was set as $T_{min} = 233$ K. The finite element mesh had the same parameters as in static strength studies. As a result of the calculation, the net heat flux mean over the upper face surface per unit area was found out. In this calculation scheme, heat is transferred only due to thermal conductivity, because assumptions were made that heat convection is negligible due to a very small residual pressure in the intra-cavities of honeycomb panels (absolute pressure is less than 1 kPa), while heat radiation is also small because of combs acting as shields. The pattern of temperature values definition on honeycomb panel faces and the diagram of resultant heat flux calculation results are shown on Figure 7.

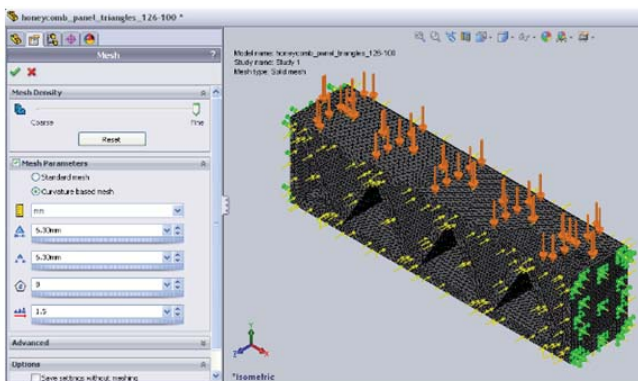

Figure 6: Mesh parameters for calculation of panels' static strength

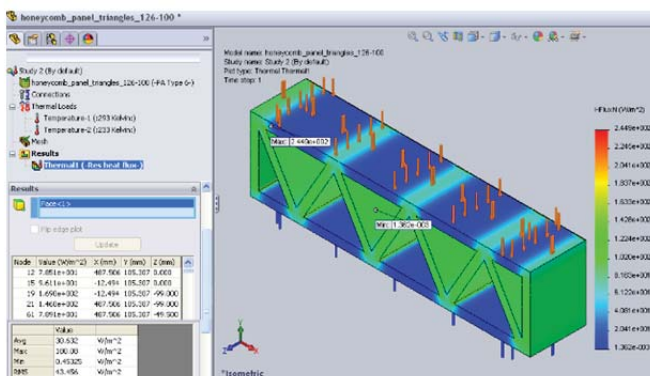
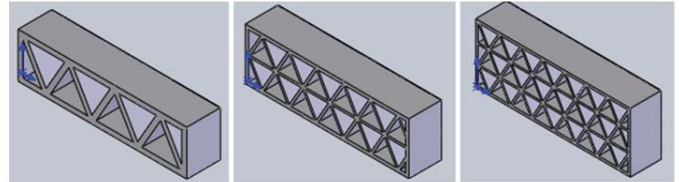

Figure 7: Diagram of temperature setting on honeycomb panel faces

Based on the optimizing honeycomb panel parameters in the SolidWorks, models with different number of cell rows and cells in one row were constructed. Figure 8 shows basic types of honeycomb panel models.

Figure 8: Basic types of honeycomb panel models: a) triangles arranged in one row; b) triangles arranged in two rows; c) triangles arranged in three rows



By changing global variables in the models, the number of combs was altered from 3 to 16, and the thickness of the panels' outer walls/inner ribs from 2 to 20 mm.

Optimization of honeycomb panel parameters, as part of the study of static strength and thermal properties in the SolidWorks Simulation, was carried out by a sequential search [02] (p.177) of variants for the following parameters:

- the thickness of panels' outer walls S was taken equal to the thickness of inner ribs S_r , which was gradually increased by 1 mm in the study for static strength in the SolidWorks Simulation starting from 2 mm up to the value that ensured the minimal factor of safety overshoot by a value of 2;
- the thickness of inner ribs S_r was sequentially reduced by 0.1 mm to the value which, with tolerance not exceeding 0.5%, assured the equality of the minimal factor of safety to the value of 2, which is permissible in the railroad car body;
- the number of cells N was changed in a row from 2 to 8;
- the number of cell rows N_r was changed from 1 to 3.

RESULTS

Railroad car models: study results

Static strength studies in the SolidWorks Simulation of a 3D model of a passenger railroad car body (made of solid plates of the same thickness for each part of the body), allow us to define the minimum permissible thickness of plates used for the floor, sidewalls, end walls and roof of the car, provided that the minimum factor of safety value 2 ± 0.01 remained the same for the whole model.

Similar studies of a 3D model of an insulated car made of solid plates allowed us to define the minimum permissible thickness of the plates for the floor, side and end walls and roof of the car.

For each part of the cars, their mass characteristics were defined in the SolidWorks Simulation for the material used — aluminium alloy 6063-T83, along with the areas of the car's outer surface exclusive of doors and windows. The results of the studies of car models made of solid plates of different thickness are shown in Table 1.

Standard solid plate models: study results

In the SolidWorks Simulation studies for static strength on standard solid plate models (aluminium alloy 6063-T83, width 500 mm, length 100 mm, different thickness), the following parameters were defined for each plate: its mass M_{sp} and the maximum permissible force F whose value was determined provided that the minimum factor of safety remained equal to 2 ± 0.01 for the plate fixation and loading pattern that is showed on Figure 4. Results of studies on solid plate models with the thickness of 20 mm, 25 mm, 30 mm, 40 mm, 54 mm are shown in Table 2.

Results of studies on standard honeycomb panel models

SolidWorks Simulation studies for static strength on standard honeycomb panel models (polyamide PA-6, width 500 mm, length 100 mm) with different numbers of triangle cells in each row N , number of cell rows N_r , outer panel wall thickness S and inner rib thickness S_r , proceeded as a sequential selection of values of S and S_r for each combination of parameters N and N_r . The values were selected so that to ensure the minimum factor of safety of 2 ± 0.01 for the panel fixing and loading scheme (see Figure 5), when loaded by pressure $100\ 000 P_s$ at all six outer faces and by force F (values are given in Table 2). After finding values S and S_r , for each honeycomb panel, its mass M_{cp} and the net heat flux W , per unit area, were determined. The W value was found as mean over the area of the upper panel face upon which, as it is shown on Figure 7, the maximum temperature T_{max} was set. From the value of W and the difference of temperatures given on the upper and bottom faces of the panel, the average heat resistance was found by the Equation (4):

$$R_{tcp} = \frac{T_{max} - T_{min}}{W} \tag{4}$$

From the values of mass and heat resistance of standard solid plates and honeycomb panels, by Equation (1) the optimality criterion for each panel structure type was determined.

Results of optimality criterion C_{opt} calculation for honeycomb panels at weighting factor values $a = 0.5$; 0.75 (recommended for insulated railroad car body) are presented on Figure 9.

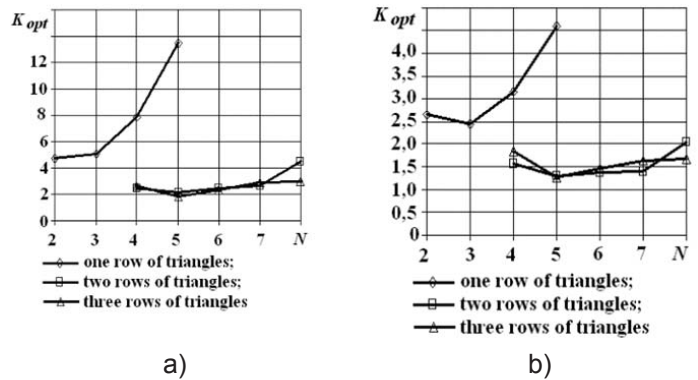

Figure 9: Dependence of optimality criterion C_{opt} for honeycomb panels (polyamide PA-6) that are equivalent in strength to a solid plate (aluminium alloy 6063-T83, thickness 54 mm), on the number of cells in one row N and the number of rows N_r at: a) $a = 0.5$; b) $a = 0.75$

As can be seen from the graphs on Figure 9, minimal values of the optimality criterion C_{opt} are observed for honeycomb panels with cell number $N = 5$ and row number $N_r = 3$.

This type of honeycomb panel structure can be recommended for insulated cars. Results of optimality criterion C_{opt} calculation for honeycomb panels at weighting factor values $a = 1.5$; 2 (recommended for passenger railroad car body) are presented on Figure 10.

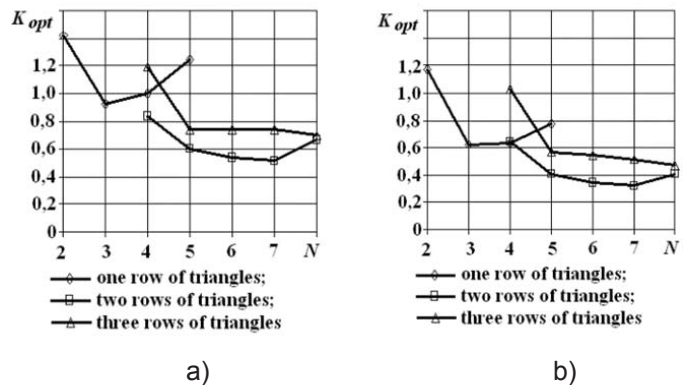

Figure 10: Dependence of optimality criterion C_{opt} for honeycomb panels (polyamide PA-6) that are equivalent in strength to a solid plate (aluminium alloy 6063-T83, thickness 40 mm), on the number of cells in one row N and the number of rows N_r at: a) $a = 1.5$; b) $a = 2$

As can be seen from the graphs on Figure 10, minimal values of the optimality criterion C_{opt} are observed for honeycomb panels with cell number $N = 7$ and row number $N_r = 2$. This type of honeycomb panel structure can be recommended for passenger cars.

Table 1: Results of studies on railroad car models made of solid plates

Car type, part of the car	Plate thickness, mm	Mass, kg	Outer surface area, m ²	Models of cars and their parts made of solid plates
Passenger car				
Bottom	40	9 093.6	84.2	
Sidewall	25	3 658.5	54.2	
End wall	25	281.5	4.17	
Roof	20	4 176	77.3	
Car body	—	21 149.6	278.24	
Insulated car				
Bottom	54	10 862.1	74.5	
Sidewall	30	4 981.5	61.5	
End wall	30	756	9.3	
Roof	20	3 699	68.5	
Car body	—	26 036.1	284.6	

Table 2: Results of the calculations of maximum forces for the models of solid plates of different thickness

Plate parameters	Plate thickness, mm				
	20	25	30	40	54
Mass M_{sp} , kg	2.70	3.37	4.05	5.40	7.29
Maximum permissible force F , N	19 200	28 125	37 300	58 000	91 200

Calculations of mass and heat resistance of railroad car bodies

Optimal honeycomb panel structure types were determined in section **Results of studies on standard honeycomb panel models** for passenger and insulated cars, at maximum forces defined in section **Standard solid plate models**: study results for the bottom of each car type: for a passenger car, $F = 58\ 000\ N$, for a thermally insulated car, $F = 91\ 200\ N$. In order to make honeycomb panels more or less of the same thickness in different parts of the car body, it seems reasonable to retain the panel structure that was chosen for the bottom (number of cells in one row, number of rows) in all other parts of the car body (side and end walls, roof). On the other hand, since the maximum permissible forces F for these parts of the car body are less than those for the bottom (see Table 1), for each part of the body, individual thickness values for the panels' outer walls S and the inner ribs S_r were chosen, which provides the minimal factor of safety of 2 ± 0.01 .

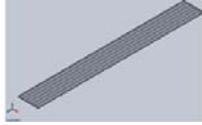
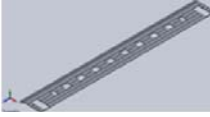
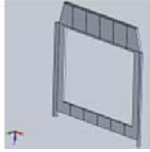
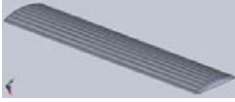
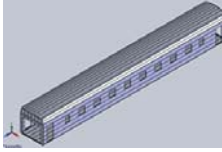
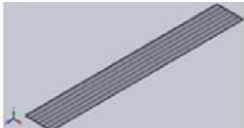
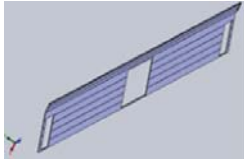
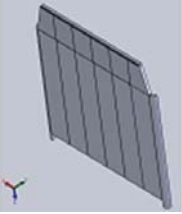
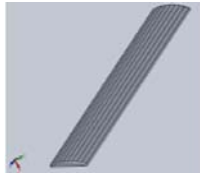
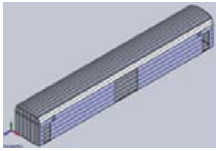
Results of mass and heat resistance analysis for different parts of passenger and insulated car models made of honeycomb panels with optimally chosen parameters for the used material (polyamide PA-6) are shown in Table 3.

DISCUSSION

The studies by the authors elaborate the ideas of [19], where it was suggested to use in the car body structure honeycomb panels whose inner cavities are pumped out to the value of residual pressure 1 kPa.

The innovation compared to the previous works is an algorithm proposed by the authors for optimizing the structure of railroad car body made of vacuum honeycomb panels, by the criterion of minimal mass with a preset strength and criterion of maximum thermal resistance.

Calculations along the proposed algorithm have demonstrated that optimization by the two criteria leads to opposing results; considering this, a generalized optimization criterion for honeycomb panel structure was put forward (see Equation (1)) that allows us to set weighting factors (impact factors) for the criterion of a minimal mass of the car body and criterion of maximum heat resistance of the car body's enclosure.

A mass factor value for passenger cars was recommended in the range of 1.5-2, for insulated cars - in the range of 0.5-0.75.

Significance of the results obtained in the study consists in the fact that the optimum honeycomb panel structure variants for the bottom of the car body were revealed based on the optimization criterion minimum. The resulting optimum structures showed a much better performance than the currently used honeycomb structure [14] (p. 7) with one row of triangle cells. For the models of the car bodies formed with honeycomb panels of the optimal structure, mass and surface-averaged thermal resistance were calculated. The found thermal resistance value of passenger car body's enclosure is in full compliance with the Russian National Standard [05] (p.2). The mass of the body of an insulated wagon made of polyamide PA-6 is considerably smaller (1.5 times) than that of a passenger car [03] (p. 5) and the insulated railroad car suggested in [18], which proves the applicability of the tested material in the supporting structure of railroad car bodies.

CONCLUSION

In this paper, it was suggested to use in the car body frame honeycomb panels whose inner cavities are pumped out to the value of 1 kPa residual pressure, whereas panels' structure is chosen so that to ensure a minimal wagon mass and its maximum heat resistance.

An algorithm is suggested for optimizing the structure of railroad car body made of vacuum honeycomb panels, by the criterion of a minimal mass with preset strength and by the criterion of maximum thermal resistance.

An optimization criterion was suggested for the honeycomb structure of panels, which made it possible to select the panel geometry ensuring a minimal body mass for a passenger or insulated railroad car and the best thermal resistance for its enclosure, with different levels of significance for these factors.

Tests of the models of passenger/insulated railroad car bodies made of solid plates for static load strength identified the minimum permissible plate thickness for different parts of the car body.

Comparative trials and examinations of solid plates and honeycomb panels revealed the optimum honeycomb panel structures for different parts of the car body based on the minimum of the optimization criterion.

When solid plates were replaced with profile-optimized honeycomb panels in car body models, the mass and thermal resistance of the cars were determined. For a passenger car, the mass of the body amounted to 11.14 t, the average thermal resistance — 3.187 m²K/W; for an insulated car the mass of the body was 20.42 t and the average thermal resistance — 6.211 m²K/W.

Table 3: Mass and heat resistance of railroad car models made of honeycomb panels (polyamide PA-6)

Car type, part of the car	Panels' outer wall thickness S, mm	Inner ribs thickness Sr, mm	Panel thickness, mm	Mass, kg	Average thermal resistance, (m ² K)/W
Passenger car					
Bottom	8.5	5.9	114.6	4 327.9	2.231
Sidewall	4.2	3.8	109.9	1 671.8	3.518
End wall	4.2	3.8	109.9	128.6	3.518
Roof	3.7	3.6	109.4	2 211.7	3.730
Car body	—	—	—	10 140.4	3.187
Insulated car					
Bottom	12.3	7.8	230.7	7 390.4	4.093
Sidewall	6.6	5.8	226.5	4 206.6	6.071
End wall	6.6	5.8	226.5	638.4	6.071
Roof	5.3	3.8	227.0	3 342.8	8.802
Car body	—	—	—	20 423.2	6.211

The calculations have proved that the tested material, polyamide PA-6, can be used in the supporting structure of a railroad car body.

The goal of further studies on the use of vacuum honeycomb panels in railroad car bodies is to be optimization of honeycomb panels with a rhomboid or hexagonal structure.

REFERENCES

- Artemyev, R. I., Balalayev, A. N., & Kiselev, D. A. (2016). Algoritm proektirovaniya kuzova passazhirskogo vagona iz alyuminievyykh ekstrudirovannykh paneley [An algorithm for designing railroad passenger car bodies from extruded aluminum panels], *Novaya nauka: opyt, traditsii, innovatsii: Mezhdunarodnoe nauchnoe periodicheskoe izdanie po itogam Mezhdunarodnoy nauchno-prakticheskoy konferentsii (24 aprelya 2016 g., g. Omsk)* [New science: experience, traditions, innovation. International scientific serial following the International Scientific and Practical Conference (April 24th, 2016, city of Omsk, Russian Federation)]. (Part 2, pp. 107–117). Sterlitamak: AMI. (In Russian).
- Attetkov, A. V., Galkin, S. V., & Zarubin, V. S. (2003). *Metody optimizatsii: Uchebnik dlya vuzov [Optimization methods: A university handbook]* (2nd ed., reprinted). Moscow: Moscow State Technical University Press. (In Russian).
- Bombardier (2011). INNOVIA ART 200 Environmental Product Declaration. Retrieved from <http://www.bombardier.com/content/dam/Websites/bombardiercom/supporting-documents/Sustainability/Reports/BT/Bombardier-Transportation-EPD-INNOVIA-ART-200-en.pdf>.
- Borovkov, A. I., Burdakov, S. F., Klyavin, O. I., Melnikova, M. P., Mikhaylov, A. A., Nemov, A. S., Palmov, V. A., & Silina, E. N. (2012). *Kompyuternyy inzhiniring. Analiticheskiy obzor: uchebnoe posobie [Computer-aided engineering. An analytical review. Manual]*. St. Petersburg: St. Petersburg Polytechnic University. (In Russian).
- GOST R 51690-2000 (2000). "Vagony passazhirskie magistralnykh zheleznnykh dorog kolei 1520 mm" [Russian State Standard GOST No. 51690-2000 "Passenger cars for main railway lines, gauge 1520 mm"]. Gosstandart Rossii, Moscow, 2000. (In Russian). Retrieved from <http://vsegost.com/Catalog/28/28489.shtml>
- Dostal, M. (2012). *DB-Wagen. Reisezug- und Güterwagen der Deutschen Bahn*. München: GeraMond. (In German).
- ECSS-Q-ST-70-09C (2008). Measurements of thermo-optical properties of thermal control materials. Space product assurance. [pdf] ECSS Secretariat ESA-ESTEC Requirements & Standards Division, Noordwijk, The Netherlands, 31 July 2008. Retrieved from <https://escies.org/download/webDocumentFile?id=62828>
- Finckenor, M. M., & Dooling, D. (1999). *Multilayer Insulation Material Guidelines, MSFC-RPT-653A*. [pdf] MSFC, Alabama, April 1999. Retrieved from <https://ntrs.nasa.gov/archive/nasa/casi.ntrs.nasa.gov/19990047691.pdf>
- Karminskiy, V. D. (2005). *Tekhnicheskaya termodynamika i teploperedacha: Kurs lektsiy [Engineering thermodynamics and heat transfer: A lecture course]*. Moscow: Marshrut. (In Russian).

11. Kelley, C. T. (1999). Iterative methods for optimization. [pdf] SIAM, Philadelphia, 1999. Retrieved from http://www.siam.org/books/textbooks/fr18_book.pdf
12. Konyukhov, A. D., Zhuravleva, L. V., & Shurtakov, A. K. (2007). Ekstrudirovannye alyuminievye paneli — perspektivnyy material dlya kuzovov vagonov [Extruded aluminum panels: a promising material for railroad car bodies. Vagony i vagonnoe khozyaystvo, 2, 36–38. (In Russian).
13. Levental, L. Ya., & Kostin, A. V. (1998). Energetika refrizheratornykh i passazhirsikh vagonov: Uchebnoe posobie [Energy engineering of passenger cars and refrigerated wagons: Manual]. Moscow: MIIT. (In Russian).
14. Normy dlya rascheta i proektirovaniya vagonov zheleznykh dorog MPS kolei 1520 mm (nesamokhodnykh). Uverzhdeny Ministerstvom putey soobshcheniya Rossiyskoy Federatsii, Komitetom Rossiyskoy Federatsii po mashinostroeniyu 22.02.1996 (1996) [“Norms and standards for calculation and designing of railroad cars, Ministry of Transport, gauge 1520 mm, unpowered vehicles”. Approved and adopted by the Ministry of Transport of the Russian Federation and Committee for Mechanical Engineering of the Russian Federation, as of February 22, 1996]. GosNIIV — VNIIZhT, Moscow, 1996. (In Russian).
15. Sapa (2010). Sapa Mass Transportation. Retrieved from http://www.sapagroup.com/companies/Sapa%20Mass%20Transportation/Documents/Rail-Rolling_Stock.pdf (Accessed 2008)
16. Tsygan, B. G. (Ed.) (2008) Sovremennoe vagonostroenie [Railroad car building today]. (In 4 vols. Vol. 1. Organizatsiya i tekhnologiya proizvodstva metallokonstruktsiy vagonov [Organization and technology of railroad cars’ metal structure fabrication]). Kharkov: Tekhnostandart. (In Russian).
17. Tsygan, B. G. (Ed.) (2012). Sovremennoe vagonostroenie [Railroad car building today]. (In 4 vols. Vol. 3. Zheleznodorozhnyy podvizhnoy sostav [Railway rolling stock]). Kremenuchug: Kremenuchugskaya gorodskaya tipografiya. (In Russian).
18. Uralvagonzavod (n.d.). Vagon-khopper dlya mineralnykh udobreniy model 19-5167 [Hopper car for mineral fertilizers, model 19-5167], (In Russian). Retrieved from <http://www.uvz.ru/products/19-5167>.
19. Vladcargo (2016). Types and sizes of refrigerated, ITW and a thermos cars. RETRIEVED FROM <http://www.vladcargo.ru/info/sizes-containers-rail-cars-aircraft/types-and-sizes-of-refrigerators-cars-thermos.html>.
20. Volochek, E. S., Kiselev, D. A., & Parenjuk, M. A. (2016). Thermal properties of the body of an insulated railroad car made of extruded polyamide vacuum panels. In: Science and life: Proceedings of the international scientific conference. Czech Republic, Karlovy Vary — Russia, Moscow, 28–29 April 2016. In I. P. Klimov, I. V. Ignatko, V. B. Mantusov (Eds.). [pdf] Skleněný Můstek, Karlovy Vary — MCNIP, Kirov, 2016, pp. 15–25. (In Russian). Retrieved from api.palmknihy.cz/web/data/Book_161178.Preview.pdf
21. Zharikov, V. A. (2006). Klimaticheskie sistemy passazhirsikh vagonov [Air conditioning systems in passenger railroad cars]. Moscow: TRANSINFO. (In Russian).
22. Zhukov, I. P. (2014). Reshenie zadach teploprovodnosti metodom konechnykh elementov: uchebnoe posobie [Solving heat conduction problems by the finite elements method: Manual]. Tambov: Tambov State Technica

Paper submitted: 29.04.2017.

Paper accepted: 04.02.2018.

This is an open access article distributed under the CC BY-NC-ND 4.0 terms and conditions.