

Indexed by

## INFLUENCE OF A SYNCHRONIZED HUMAN DYNAMIC LOAD ON VIBRATIONS OF MACHINE STRUCTURES

Scopus®

**Goran Radoičić**

University "UNION-Nikola  
Tesla" Belgrade,  
Faculty of Applied Sciences,  
Niš, Serbia

**Miomir Jovanović**

University of Niš,  
Faculty of Mechanical  
Engineering,  
Niš, Serbia

DOAJ  
DIRECTORY OF  
OPEN ACCESS  
JOURNALS

Crossref

ROAD  
DIRECTOR OF OPEN ACCESS  
RESEARCH

**Key words:** crowd load, dynamics, Fourier series, measurement, rhythmic load, vibration

**Cite article:**

Goran, R., & Miomir, J. [2021]. Influence of a synchronized human dynamic load on vibrations of machine structures. *Journal of Applied Engineering Science*, 19(1), 237 - 245. DOI:10.5937/jaes0-28214

KoBSON

SCINDEKS  
Srpski citatni indeks

**Online access of full paper is available at:** [www.engineeringsscience.rs/browse-issues](http://www.engineeringsscience.rs/browse-issues)

Google  
Scholar

## INFLUENCE OF A SYNCHRONIZED HUMAN DYNAMIC LOAD ON VIBRATIONS OF MACHINE STRUCTURES

Goran Radoičić<sup>1\*</sup>, Miomir Jovanović<sup>2</sup>

<sup>1</sup>University "UNION-Nikola Tesla" Belgrade, Faculty of Applied Sciences, Niš, Serbia

<sup>2</sup>University of Niš, Faculty of Mechanical Engineering, Niš, Serbia

*This paper contributes to the research of rhythmic behavior of a group of people, which, more or less synchronized, moves or jumps on a thin and elastic plate, thus performing a dynamically variable load. The analysis of the rhythmic behaviour of the crowd carried out on the basis of the experimental testing on the special steel test platform. The experiment consisted of sixteen measurements of live force and acceleration of the test platform. The dynamic loads caused by the mass of the human crowd and individuals had different intensities. The measurements of acceleration of the test platform were performed in order to estimate how the live human force influences on vibrations of machine structures. This research allows us to gain a picture of how serious the threats are from some human actions on the support structure of machines that are handled when performing works in industry, construction or mining. On the basis of these experiments, the mathematical models of the equivalent excitation forces were developed. The measured accelerations of the test platform tread surface and calculated dynamic coefficients of human force indicate that similar actions can seriously endanger balance of the support structure of some machine, and even, for example, can cause the main girder of the bridge crane to fall out. This and similar experiments allow us to formulate appropriate models of excitation loads by human force, which can then be used in simulation analyses in order to develop future systems of electronic protection of machines structures from adverse events.*

*Key words: crowd load, dynamics, Fourier series, measurement, rhythmic load, vibration*

### INTRODUCTION

It is already known that one person can generate a significantly higher load on the contact surface in relation to its static action by its own body weight. If this surface with an elastic structure is part of a large or tall machine, for example, a bridge crane or scissor lift, then the question about the amount of risk for the machine to overturn due to the above-mentioned loads can be asked, whether they are incidental or tendentious. How seriously a live human force can affect technical systems with limited stability? Dynamic actions of people on the contact surface of an elastic structure, caused by the movement of their own body weight, are divided into three categories according to the frequency and amplitude of the human force, that is: walking and running loads, jumping load and rhythmic exercise load. Walking means moving the centre of gravity of the human body in a predominantly horizontal direction with alternating slight raising and lowering vertically. Walking and running together have a very small impact force in the frequency range of 1.4-2.2 Hz [1]. Higher loads on the contact or bearing surface can be caused by walking and running only in the case of a large number of people. The next category – jumping load leads to the vertical effect of a high-intensity force that occurs at the moment of contact of the human feet with the tread surface (so-called "landing"), so this load is much higher than the static load – own human body weight. These are impulse actions that, in addition to jumping or bouncing, can also be executed by swinging.

A good indicator of the load intensity is the dynamic coefficient. The frequency range for jumping loads is 1-3.5 Hz [2]. The third group of load – rhythmic or synchronized load is considered a subgroup of jumping load. This group implies a synchronized action of human force on the tread surface (some structure) which causes large amplitudes of movement of the whole structure or parts of the structure. The actions are more dangerous if they are performed by a larger number of people. Such actions are then called the crowd effects. The riskiest actions will be caused by live human force in a resonant mode with the structure. The recommended frequency ranges for loads caused by rhythmic jumping, which are of interest to us, according to [3] are:

- 1.2-2.8 Hz, when only one person jumps,
- 1.5-2.5 Hz, when a small group of people jumps synchronously (at aerobics),
- 1.8-2.3 Hz, for a larger group of people with synchronized movements (at a rock music concert, etc.).

The recommendation [4] gives a frequency range of 1.5-3.5 Hz in the case when one person jumps. The study [3] concludes that a larger human group cannot maintain its synchronized jumping at higher frequencies, so a more realistic upper frequency limit, for example, 2.8 Hz, should certainly be taken.

Synchronized lateral action of people on the structure is especially discussed in [5].

The diagram of the causes of harmful events on tower

cranes, Figure 1, illustrates the significance of the action live human force on the machines structure. Here we can see that the misuse class participates globally with 11% in the total number of incidents [6].

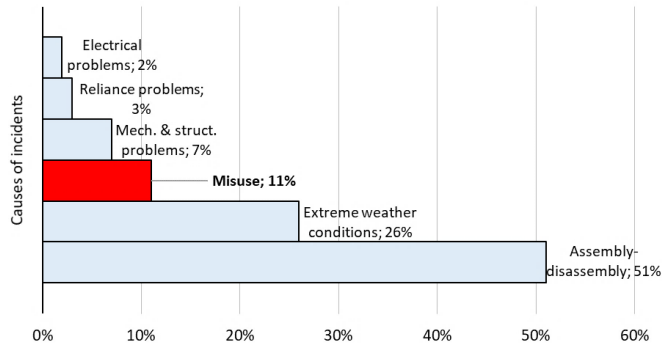

Figure 1: Causes of harmful events on tower cranes

### DYNAMIC HUMAN FORCE MODELLING

The people's action on an elastic structure – the tread of the test platform in this research, has a periodic (repetitive) character of the load. In addition, this action is synchronized (rhythmic). The mathematical model of a vertical synchronized periodic load by an individual person on a support structure can be presented by the Fourier series, [3], as:

$$F(t) = G \left[ 1 + \sum_{n=1}^{\infty} r_n \sin \left( \frac{2\pi n}{T} t + \varphi_n \right) \right] \quad (1)$$

where  $F(t)$  is the time varying force (dynamic periodic human force),  $G$  is the individual's own body weight,  $n$  is the number of the Fourier coefficient (phase),  $r_n$  is the  $n^{\text{th}}$  Fourier coefficient or dynamic load factor,  $T$  is the vibration period of the force,  $\varphi_n$  is the  $n^{\text{th}}$  phase lag factor.

The model from Eq.(1) can be applied to a group of people (so-called: crowd model), [3], i.e.

$$F(x, y, t) = G(x, y) \cdot \left[ 1 + C_c \sum_{n=1}^{\infty} r_n \sin \left( \frac{2\pi n}{T} t + \varphi_n \right) \right] \quad (2)$$

where  $F(x, y, t)$  is the varying dynamic force of the human crowd in time and distributed in the plane,  $G(x, y)$  is the crowd weight distributed in the plane,  $C_c$  is the dynamic crowd factor.

The previous expression can also be written as:

$$F(x, y, t) = G(x, y) \cdot \left[ 1 + \sum_{n=1}^{\infty} r_{n,p} \sin \left( \frac{2\pi n}{T} t + \varphi_n \right) \right] \quad (3)$$

where  $r_{n,p}$  is the  $n^{\text{th}}$  Fourier coefficient or dynamic load factor induced by  $p$  humans, [7], which can be written in the form:

$$r_{n,p} = \frac{a_n s \cdot \sqrt{(1 - n^2 \beta^2)^2 + (2\zeta n \beta)^2}}{G(2\pi n f)^2} \quad (4)$$

where  $a_n$  is the average peak acceleration for the  $n^{\text{th}}$  harmonic,  $\beta$  is the ratio of the observed rhythmic frequency

to the natural frequency of the structure,  $\zeta$  is the damping coefficient of the tread structure (e.g. bridge structure),  $s$  is the static stiffness of the tread structure,  $G$  is the generalized human crowd load.

The live human force has variable amplitudes, which in the case of the periodic force of the distributed crowd is caused by the separate development of the own weight of each individual within the crowd. In order to include the variability of the amplitude in the calculation, it is necessary to introduce a normalized force function, i.e. the weight of a human crowd that changes linearly at different time intervals. The mathematical model of the periodic force of a human crowd is represented as:

$$F(t) = G [1 + F_a(t) F_h(t)] \quad (5)$$

where  $G$  is the static load (weight) of the crowd,  $F_a(t)$  is the linearized contour function of the force amplitude,  $F_h(t) = \sin \Omega t$  is the periodic function of the human force.

### EXPERIMENTAL ANALYSIS OF A HUMAN RHYTHMIC FORCE USING THE TEST PLATFORM

In order to develop an excitation model, which is described in this paper, the experimental investigations were conducted on an elastic platform of dimensions: 1000 x 500 x 210 mm, Figures 2 and 3, which was designed just for this occasion. The scenario of the experimental testing is based on a dynamic event in which one or more people jump rhythmically on the test platform. This action aims to produce the highest possible dynamic coefficient in order to indicate the level of danger that such and similar loads can cause on the support structures of machines. Several people with different body weights participated in the experimental investigation, so a large number of trials were performed. Since the experiment is based on a simultaneous action of people, it was necessary to do several tests until successful synchronization was reached, so the dynamic factor of the group  $C_c=1$  was adopted everywhere. Boundary conditions for all tests are identified for: the values of the static load (individual body weights), the initial and final time of excitation, the current times of individual segments, i.e. experimental regimes. The results experimentally obtained were analysed together with the results from the research conducted on the support structures of machines in real working conditions, [8].

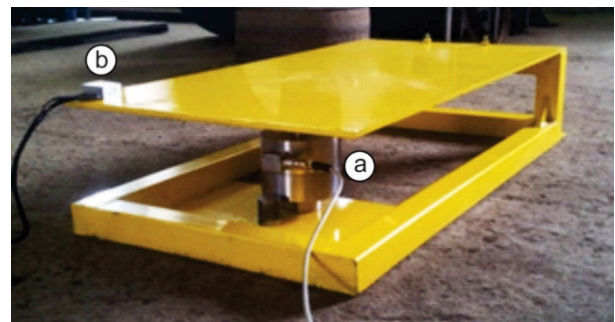

Figure 2: Test platform: (a) HBM U2A force sensor, (b) Philips 9812 acceleration sensor

The measurement of force and acceleration was carried out in conditions when one, two or at most three persons generated a load of variable intensity by jumping on the platform, depending on the experiment, Figure 3. In such conditions, "intensity 3" represented the strongest, and "intensity 1" the weakest effect. In the experiments, the action of humans on the tread surface of the platform was performed as: multi-cyclic jumping without separation from the surface, multi-cyclic jumping with separation from the surface and impulse single-cyclic action of one person. The test platform is a steel welded structure with an elastic plate for standing people. The tread plate is kinematically connected to the tubular frame in order to avoid the clamping moment in the support. The tubular frame has good stability and sufficient mass so that it cannot be detached from the floor during the test.

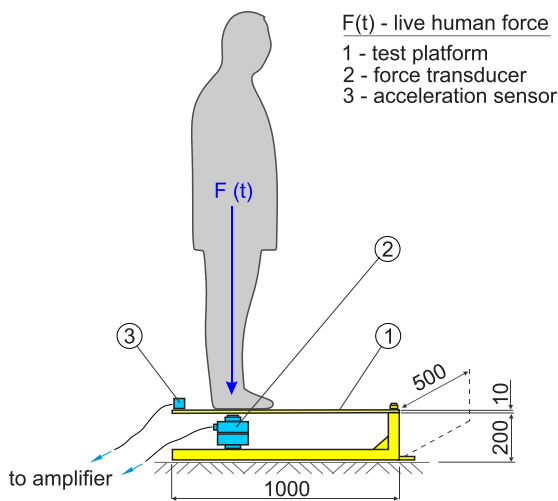

Figure 3: Experimental concept

The measuring system, Figure 2, based on the HBM MGC+ amplifier, the HBM U2A-10t dynamometer and the Philips 9812 acceleration sensor has been developed for experimental needs. The measuring system has

used the measuring bridges with full six-channel feedback connections between the amplifier and the sensors (Figure 4).

Table 1 summarizes the results of the measurement performed in the utility company "Mediana" Niš, Serbia, 2015. Significant parameters on the influence of human force on the support structure are: period of vibration, frequency, dynamic coefficient of force, and acceleration of the structure. The measured frequencies of acceleration differ from the frequencies of human force, because the acceleration sensor is placed on the tread surface of the test platform in order to measure the acceleration of that structure and not man as an excitation generator.

**ANALYSIS OF THE MEASURED PARAMETERS OF A HUMAN RHYTHMIC ACTION**

Looking at Table 1, we conclude that the frequency range of the experiments is 1.07-3.33 Hz. The highest frequency of force of 3.33 Hz was obtained in a load mode which was not rhythmic because it contained only one impulse i.e. a sudden jump of one man on the platform tread surface (Figure 5). The frequency range of the remaining measurements is 1.07-2.39 Hz.

The greatest human force obtained by the measurement is 5.49 kN (Figure 6, test no. 16). This force was produced by a group of three people. However, the frequency of this action belongs to the rank of the lowest frequencies.

The dynamic coefficient of force indicates the scale of the action and the level of risk for an incident on a structure. The dynamic coefficient of live human action is the ratio of maximum measured force when jumping a person (or a group which is a dynamic load), and the force of own body weight of the same person (or the same group) at standing, which is a static load. This coefficient is shown in Figure 7, relative to the human crowd size. Based on the diagram, we can draw conclusions about the impacts of different sizes of the crowd.

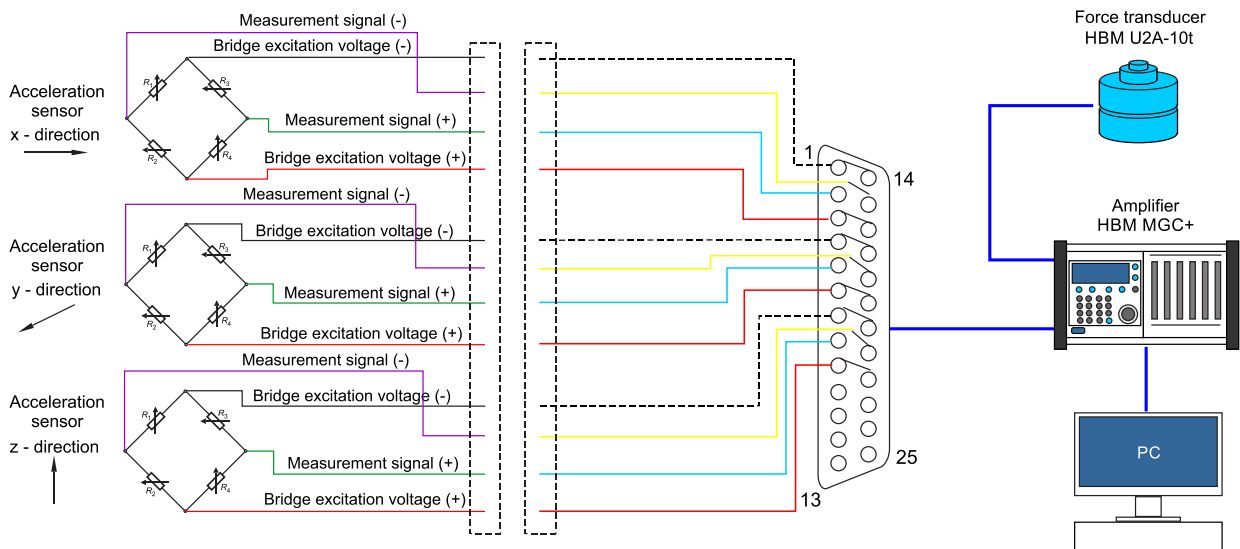

Figure 4: Measuring system



In most of the measurements, we see that the increase in the number of people in the jumping group, as a rule, does not mean a higher dynamic coefficient of that action. On the contrary, the largest increase in the dynamic force in relation to the static size of its own weight was recorded in the actions of one person, in the measurements no. T.4, T.2, T.3 and T.6, Figure 7, when the dynamic coefficients were in the range of the highest values. On the other side, the weakest results of the dynamic coefficients were recorded in the experiments no. T.15 and T.16 with the largest number of people in the group (three person). Why is that so? All measurements were performed in real conditions and with certain limitations such as:

- the test platform of small tread area (Figure 3, 1000 x 500 mm) on which it is difficult to accommodate two or three people;
- difficult synchronization, i.e. phase coordination of actions of people who are on the stand (platform) at the same time, especially when several people of different weights are in a small area;
- different motivational (biorhythmic) levels of persons on the platform - demonstrators during the experiment.

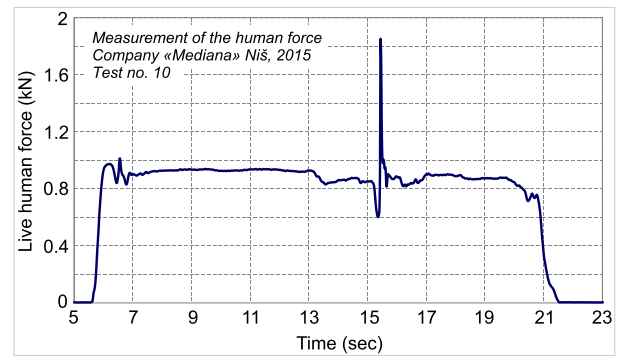

Figure 5: Impulse human action

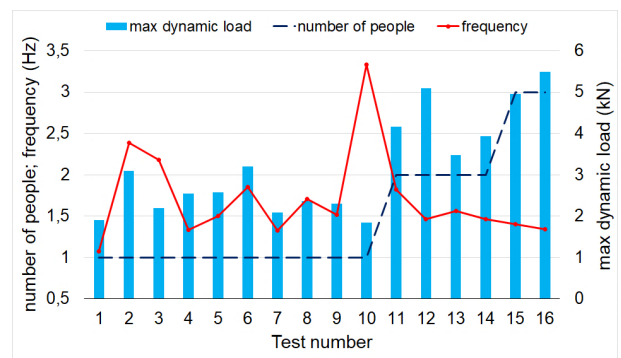

Figure 6: Experimentally obtained dynamic parameters of the human load

Table 1: Summary of the results obtained by the experimental testing

Number of persons	Test no.	Load intensity	Period of vibration	Frequency	Number of amplitudes	Human force max	Human weight force (static)	Dynamic coefficient	Acceleration max (x-dir.)	Acceleration max (y-dir.)
		1÷3	$T [s]$	$f=1/T [Hz]$	$N$	$F_m [kN]$	$W [kN]$	$kF=F_m/W$	$ a_x  [m/s^2]$	$ a_y  [m/s^2]$
1	T.1	2	0.93	1.07	14	1.90	0.85	2.24	3.96	11.00
	T.2	3	0.42	2.39	49	3.09	1.05	2.94	1.89	18.20
	T.3	3	0.46	2.18	34	2.20	0.80	2.75	9.61	25.26
	T.4	3	0.75	1.33	44	2.54	0.80	3.18	1.60	5.26
	T.5	2	0.67	1.50	31	2.57	1.20	2.14	0.83	3.80
	T.6	3	0.54	1.85	15	3.20	1.20	2.67	12.60	O.M.R.*
	T.7	2	0.75	1.33	13	2.08	0.85	2.45	2.39	6.90
	T.8	3	0.59	1.71	38	2.36	1.05	2.25	0.98	2.52
	T.9	3	0.66	1.52	25	2.30	1.05	2.19	10.68	17.60
	T.10	1	0.30	3.33	1	1.84	0.85	2.16	7.56	O.M.R.*
2	T.11	2	0.55	1.82	15	4.16	2.05	2.03	7.02	12.14
	T.12	3	0.68	1.46	9	5.09	2.05	2.48	5.78	14.22
	T.13	3	0.64	1.57	19	3.47	1.65	2.10	12.38	O.M.R.*
	T.14	3	0.68	1.47	16	3.94	1.65	2.39	9.00	O.M.R.*
3	T.15	3	0.71	1.40	10	4.95	2.85	1.74	5.21	17.92
	T.16	3	0.75	1.34	8	5.49	2.85	1.93	5.82	17.83

\* the magnitude was not in the measuring range of the instrument (OMR=Outside the Measuring Range)

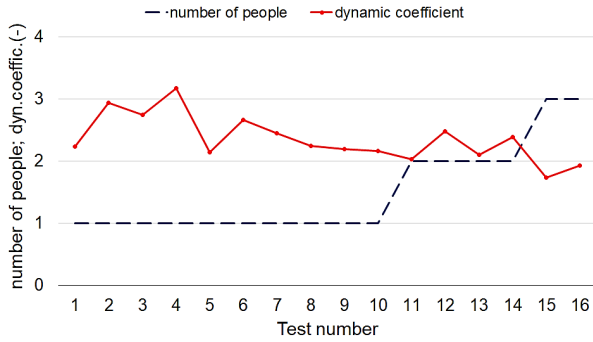

Figure 7: Dynamic coefficients in relation to the group size

If the stated imperfections of the experiment could be overcome, it would increase the dynamic coefficient of action of a larger number of people who make up the group.

Figure 8 shows the results obtained by measurement of the live force of the group of two (test no. 12) and three people (test no. 16). These two measurements are interesting because they recorded the greatest dynamic forces obtained by human action, observing all conducted experiments. The segments, or more precisely, the periods of the full amplitudes are marked on the diagrams to be taken in the calculation of the mean frequency of the human force. The calculation was performed by the arithmetic mean method.

The mean values of the vibration period in the force measurements from Figure 8 are:

$$T_m(T.12) = \frac{t_9(T.12) - t_0(T.12)}{N(T.12)} = \frac{16,4 - 10,28}{9} = 0,68 \text{ [sec]}$$

$$T_m(T.16) = \frac{t_8(T.16) - t_0(T.16)}{N(T.16)} = \frac{47,82 - 41,82}{8} = 0,75 \text{ [sec]}$$

Where  $t$  is the real time at the end or beginning of the segments, and  $N$  is the number of the full force amplitudes.

The mean values of the human force frequencies in both cases are:

$$f_m(T.12) = \frac{1}{T_m(T.12)} = \frac{1}{0,68} = 1,46 \text{ [Hz]}$$

$$f_m(T.16) = \frac{1}{T_m(T.16)} = \frac{1}{0,75} = 1,34 \text{ [Hz]}$$

The mean values of the human force frequencies for the remaining measurements were calculated by the same method (Table 1). In two of the six force measurements, when jumping the group of two and three members, the frequencies whose mean values belong to the recommended range ( $\geq 1.5$  Hz) were recorded. These values are slightly lower (1.34-1.47 Hz) in the four remaining measurements. Such results indicate incomplete synchronization of the rhythmic behaviour of the group, which means that a value of the dynamic crowd factor is less than one ( $C_c < 1$ ).

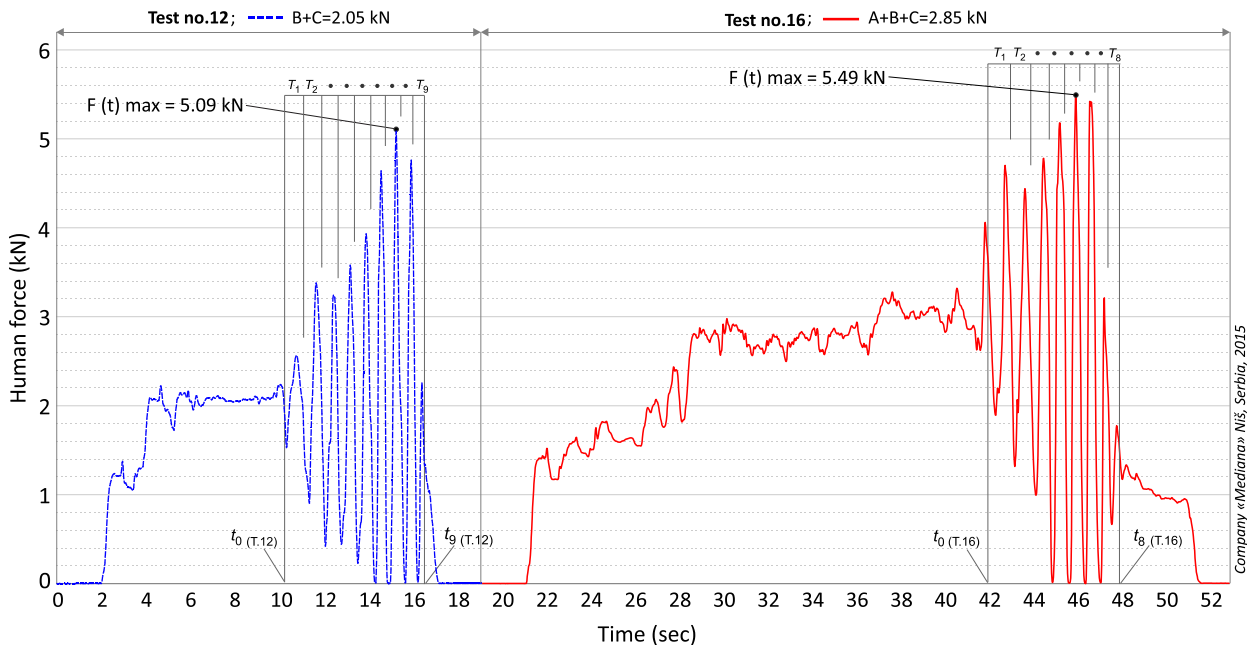

Figure 8: Measurement of the live human force; Test no.12 (two persons); Test no.16 (three persons)

The dynamic coefficient of human action is:

$$k_F = \frac{F_m}{W} \tag{6}$$

where  $F_m$  is the maximum human dynamic force, and  $W$  is the body weight of people in the group (static effect of people).

For these two selected measurements, the dynamic coefficients are:

$$k_{F(T.12)} = \frac{F_m(T.12)}{W(T.12)} = \frac{0,509}{0,205} = 2,48$$

$$k_{F(T.16)} = \frac{F_m(T.16)}{W(T.16)} = \frac{0,549}{0,285} = 1,93$$

These are not the highest values of the dynamic coefficient in these experiments. Namely, higher values of this coefficient were recorded in several measurements when there was one person on the test platform instead of the group. We could draw two important conclusions regarding dynamic coefficients. The first of them refers only to the performed experimental research and reads: The dynamic coefficient decreases with increasing the number of persons who make up the rhythmic load on the test platform (see Table 1).

To draw the second conclusion, we will look at the human actions on the platform by different individuals with different own body weights  $W$ . We can use Figure 9 which shows the measured human dynamic forces generated by jumping person A (80 kg, test no. 4) and person B (120 kg, test no. 5). The dynamic coefficients of these forces are:

$$k_{F(T.4)} = \frac{F_{m(T.4)}}{W_{(T.4)}} = \frac{0,254}{0,08} = 3,18$$

$$k_{F(T.5)} = \frac{F_{m(T.5)}}{W_{(T.5)}} = \frac{0,257}{0,12} = 2,14$$

$$k_{F(T.5)} = 2,14 < k_{F(T.4)} = 3,18$$

Thus, the dynamic coefficient of live force generated by jumping of a heavier person is smaller than in the case of a lighter person.

If we generalize this fact, we can put forward the thesis that people have a smaller reserve of own human strength. The reserve of strength is first determined by the condition of the person and his age. Therefore, mathematical modelling of the excitation force at incidental or malicious human actions on the large machine structures should be executed on the basis of those experiments in which:

- the number of participant (persons) is one or two;
- participants in the experiment show a greater strength reserve;
- participants (as members of a group) in the experiment realize better rhythmic synchronization at jumping, so the synchronization factor is close to "one".

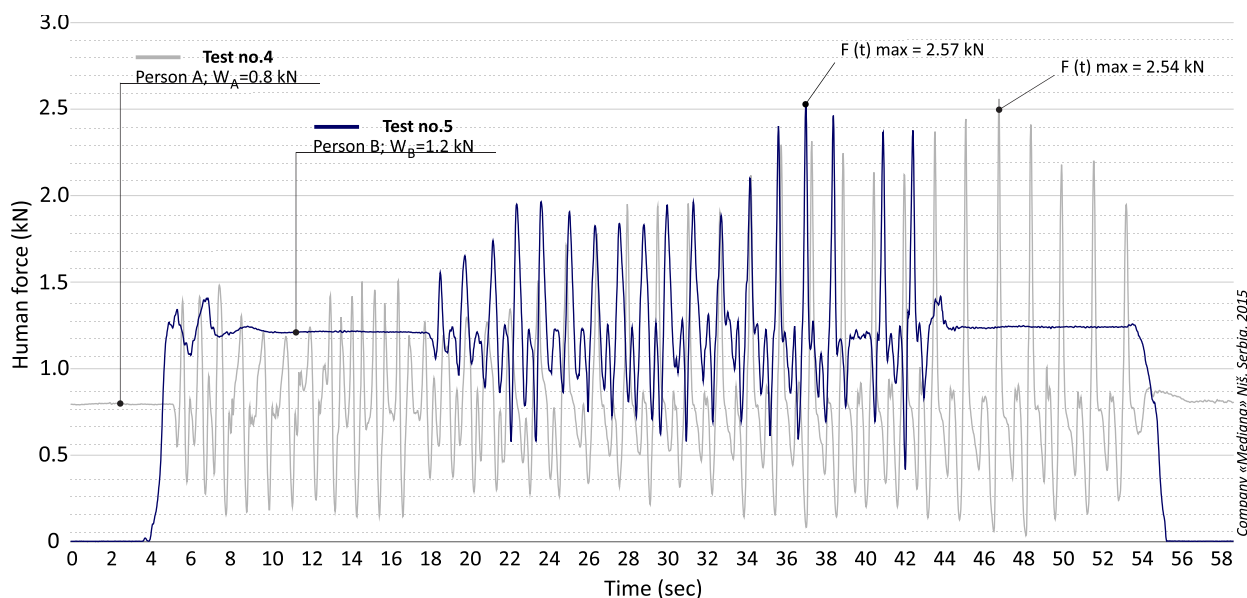

Figure 9: Measurement of the dynamic force of a person; Test no.4 – person A; Test no.5 – person B

### DYNAMIC EXCITATION MODEL FOR APPLICATION IN SIMULATION ANALYZES

For numerical (theoretical) modelling of the force of rhythmic human action, the force diagram from the experiment no. 3, Figure 10, was taken for the following reasons: the excitation is realized by one person with large own power reserve (whose the dynamic coefficient is even 2.75); the experiment is clearly divided into three zones, more precisely, two zones of the static load (at the beginning and end) and one central zone of the dynamic rhythmic load; the dynamic change of human load (in the middle zone II) is performed in a sufficient number of cycles (periods) in which the full amplitudes of force are achieved, except in a few cycles at the very beginning and end of the dy-

namic action, which can be considered insignificant.

We will pay attention to the dynamic force (load) by one person, which is shown in Zone II on the diagram. Frequency of a rhythmic load can be calculated using the period of vibration. The mean value of the vibration period is the ratio of the total duration of the rhythmic load and the number of full amplitudes of the human force in Zone II from Figure 10, i.e.

$$T_{m,II} = \frac{1}{n} \sum_{i=1}^n T_{i,II} = \frac{T_1 + T_2 + \dots + T_{34}}{n} = \frac{t_6 - t_1}{n} = \frac{27,46 - 11,86}{34} = 0,46 \text{ [sec]}$$

The mean value of the frequency is

$$f_{m,II} = \frac{1}{T_{m,II}} = \frac{1}{0,46} = 2,18 \text{ [Hz]}$$

and the mean circular frequency is

$$\omega_{m,II} = \frac{2\pi}{T_{m,II}} = \frac{2\pi}{0,46} = 13,65 \left[ \frac{\text{rad}}{\text{sec}} \right]$$

If we go back to Eq.(5) which reads

$$F(t) = G[1 + F_a(t)F_h(t)]$$

we see the following known quantities:

$G=W_A=0,08$  is the static weight from a particular person and  $F_h(t) = \sin(13,65)t$  is the periodic function.

So, for modelling the live force, we should define the linearized contour function of the amplitude  $F_a(t)$ . It will be done in the time intervals from Figure 10. This function can be represented numerically by a set of interval equations, (7).

$$F_a(t) \begin{cases} F_0 = 0, & t = t_0 \\ F_1 = F_0 = 0, & t = t_0 \div t_1 \\ F_2(t) = F_2 \left( \frac{t-t_1}{t_2-t_1} \right), & t = t_1 \div t_2 \\ F_3(t) = F_2 + (1-F_2) \left( \frac{t-t_2}{t_3-t_2} \right), & t = t_2 \div t_3 \\ F_4(t) = F_3 = 1, & t = t_3 \div t_4 \\ F_5(t) = (F_5 - 1) \left( \frac{t-t_4}{t_5-t_4} \right), & t = t_4 \div t_5 \\ F_6(t) = F_5 \left( \frac{t_6-t}{t_6-t_5} \right), & t = t_5 \div t_6 \\ F_7 = F_6 = 0, & t = t_6 \div t_7 \end{cases} \quad (7)$$

On the basis of the calculated frequency from the selected measurement (Test no. 3) and the linearized shape function  $F_a(t)$  from Eq.(7), we can write the following mathematical model of the excitation force:

$$F(t) = 0,08[1 + F_a(t)\sin(13,65)t] \quad (8)$$

where is

$$F_a(t) = \sum_{j=1}^p F_j(t) \quad (9)$$

and where  $p=5$  represents the number of intervals in the zone of dynamic load caused by the live force (Zone II in Figure 10).

The model of dynamic excitation by human force formulated in this way was applied in simulations with the FEM models, which were previously developed in [8] to [10]. The purpose of these FEM models has been to determine the dynamic behaviour of a seventeen-ton bridge crane structure of the MIN-D800 type which had the load capacity of 5 t and span of 30 m. One modal vibration shape of the mention crane (mode 29, eigenfrequency 2.34 Hz) loaded with the force model from Eq.(5), whose the linearized form is given in Eq.(7), and  $G$  is the static weight of a human crowd, is shown by the FEM model in Figure 11.

The experimental research conducted in 2012 and published in [11] shows that not always a lot of energy is needed to cause an incident and that the energy of just one person can be enough. An example of such a risk of rhythmic excitation of hanging masses are mobile elevating work platforms. Their boom structure in the form of "branch" is characterized by limited stability. The hanging load (mass) from the platform can be easily actuated manually with dynamic behaviour up to stability limits when the vehicle can be overturned. One such earlier situation led to an incident – the service platform overturned when stability was disrupted by a dynamic impulse (type AUTEL 141C, Niš, 2005).

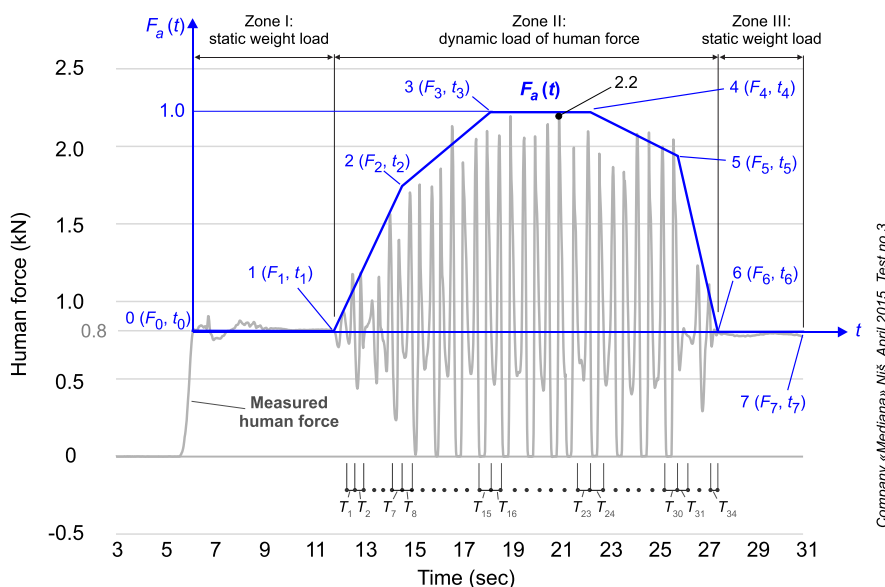

Figure 10: Modelling the human load based on the experimental results



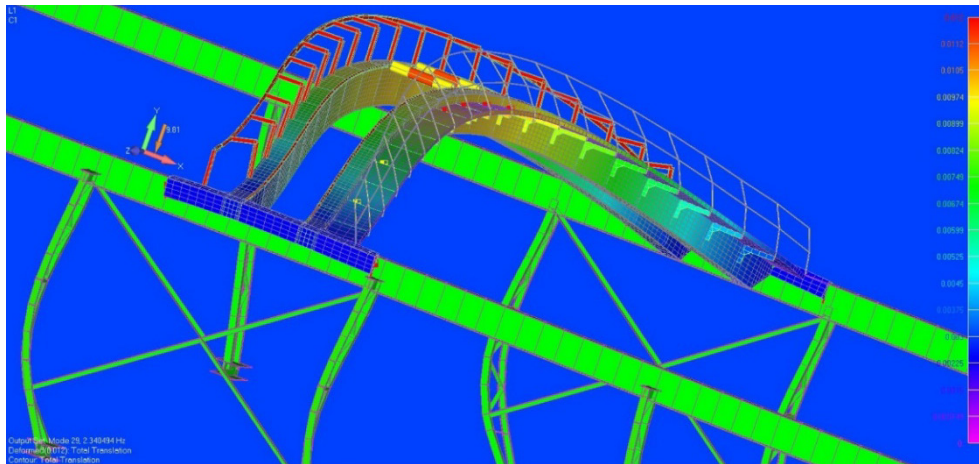

Figure 11: Deformed FEM model of the MIN-D800 bridge crane; Mode 29, Eigenfrequency 2.34 Hz

**MEASUREMENT OF ACCELERATIONS OF THE TEST PLATFORM**

Table 1 shows the magnitudes of the measured accelerations in absolute value in the: x direction in the plane of the platform which is parallel to its longitudinal axis and y in the vertical direction, through the centre of gravity of the acceleration sensor. The measured accelerations range from 0,83-12,6 m/s<sup>2</sup> in the x direction and 2.52-25.26 m/s<sup>2</sup> in the y direction. Two records of the measured accelerations are shown in Figure 12.

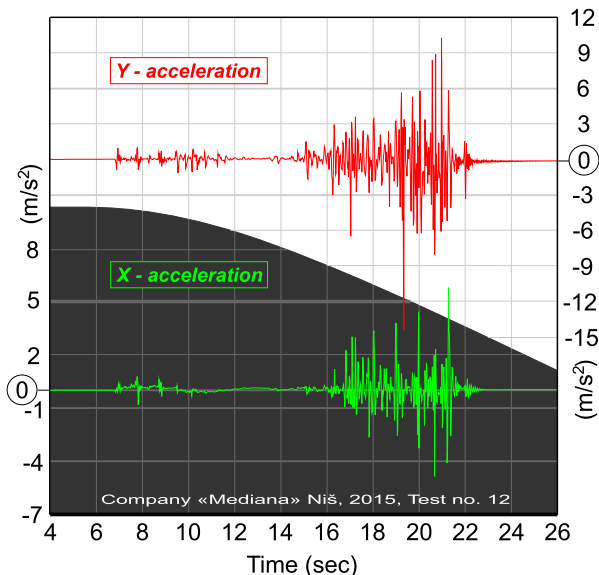

Figure 12: Two records of the measured accelerations

Since the results for similar measurements vary greatly, conclusions about accelerations based only on these experiments cannot be generalized. It should be said that the value and accuracy of accelerations were also influenced by other factors, such as the different orientation of the demonstrator on the platform (without previously established standing rules) or the problem of moving the sensor itself during the measurement. However, the measured results are logical because the values for the accelerations in the vertical direction are always about

three times higher than the values for the accelerations in the horizontal direction. There are several measurements in which the acceleration values take place outside the measuring range of the instrument and therefore they are not taken into consideration.

**CONCLUSION**

In the analyses, the rhythmic dynamic action of the human crowd on large machine structures should be considered separately from the usual action when working with these machines. For example, people who stand on a scissor lift and perform some usual maintenance procedures on the facade of a multi-storey building can be considered as a stationary load in the interaction with the machine structure, but if they start jumping inside the basket of the platform for some reason, then such load would be dynamic, and the response of the structure would depend on own elastic properties of this structure. Therefore, when designing the support structures of machines, the possibility of risk situations due to the action of a rhythmic load should be limited, and that can be achieved by increasing the lowest structural stiffness and introducing remote control of movement, i.e. by distancing people from the machine environment, if the purpose of the machine allows it.

This paper proposes a numerical (theoretical) formulation for the simulation model of jumping (dynamic) load by which a human crowd acts on an elastic structure. The dynamic crowd factor of the model is  $C_e=1$ , which means that the model implies maximum synchronization. Since such a case is very rare in practice, the action of each individual from the group on the construction should be studied in more detail in the analyzes. In any case, the weaker synchronization of human actions within a crowd leads to energy dissipation, and thus to the damping of platform vibrations.

This experimental investigation shows that people with higher own body weight have lower dynamic coefficients, i.e. less dynamic ability. In addition, the group of two persons has less dynamic force coefficients than individuals,

and the group of three persons even less. Athletes are a special category that can create the greatest dynamics, but which is not experimentally covered by this research. This kind of human behavior represents a serious vi-bro-load for the structure, because the measured accelerations of the test platform range up to 2.5g. The accelerations of the tread plate of the test platform in the direction of the force (vertical) are three times greater than those in the horizontal plane of the plate.

Restrictions: The excitation of mechanical structures is always caused under some conditions by rhythmic action. These conditions are sufficient energy of people or group and closeness of the structural eigenvalues and the frequency of excitation. The third condition is determined by a measure that limits the stability of the mechanical structure. There, between the stated limits of energy, frequency and conditions of stability, an unpleasant excitation of the structure will occur. Unfortunately, complete protection against malicious or accidental rhythmic effects on the structure is not possible. Special carefulness should be taken when working with smaller structures such as mobile platforms.

#### REFERENCES

1. Sahnaci, C., Kasperski, M., (2005). Random loads induced by walking. *Structural Dynamics EURO-DYN 2005*, p. 441–446.
2. Littler, J.D. (2003). Frequencies of synchronized human loading from jumping and stamping. *The Structural Engineer*, vol. 22, 27–35.
3. Ellis, B.R., Ji, T., Littler, J. D. (2000). The response of grandstands to dynamic crowd loads. *Structures & Buildings*, vol. 140, 355-365.
4. BRE. BRE Digest 426: The response of structures to dynamic crowd loads, London 1997.
5. Maraveas, C., Fasoulakis, Z.C., Tsavdaridis, K.D. (2015). A review of human induced vibrations on footbridges. *American J. Eng. Applied Sci.* vol. 8, no.4, 422-433, DOI: 10.3844/ajeassp.2015.422.433.
6. Isherwood, HSE Laboratory. RR820: Tower crane incidents worldwide, from <http://www.hse.gov.uk/research/rrpdf/rr820.pdf>, accessed on 2010.
7. Ellis, B.R., Littler, J.D. (2004). Response of cantilever grandstands to crowd loads: Part 2 – load estimation. *Structures & Buildings*, vol. 157, 297-307.
8. Jovanovic, M., Radoicic, G. (2017). A human crowd effect modelled by the discrete-time Fourier series. *Facta Universitatis, Series: Working and Living Environmental Protection*, vol. 14, no. 2, 139-148, DOI:10.22190/FUWLEP1702139J
9. Jovanovic, M., Radoicic, G., Jovanovic, D., (2016). Discrete Fourier transformation model for determination of live human force based on experiment. *XIII International SAUM Conference on Systems, Automatic Control and Measurements 2016*, article B5.
10. Jovanovic, M., Radoicic, G., Jovanovic V., Tomic V., (2015). Synchronic excitation – a type of malicious dynamic action“. *International Conference on Material Handling, Constructions and Logistics – MHCL 2015*, p. 207-210.
11. Jovanovic, M., Radoicic, G., Stojanovic, V. (2019). Accuracy of incidental dynamic analysis of mobile elevating work platforms. *Structural Eng. Mech.*, vol. 71, no. 5, 553-562. DOI: <https://doi.org/10.12989/sem.2019.71.5.553>

*Paper submitted: 31.08.2020.*

*Paper accepted: 03.11.2020.*

*This is an open access article distributed under the CC BY 4.0 terms and conditions.*